

MSD INSTALLATION INSTRUCTIONS

MSD 7AL-2 Plus Ignition PN 7222

ONLINE PRODUCT REGISTRATION: Register your MSD product online. Registering your product will help if there is ever a warranty issue with your product and helps the MSD R&D team create new products that you ask for! Go to www.msperformance.com/registration.

Note: Solid Core spark plug wires cannot be used with an MSD Ignition.

Note: An MSD cannot be used on vehicles with CD ignitions or distributorless ignition systems.

Parts Included:

| | |
|---|------------------------------------|
| 1 - MSD 7AL-2 Plus Ignition | 1 - White Wire |
| 1 - Mag Pickup Extension Harness, PN 8860 | 1 - Red Wire |
| 1 - Mag Pickup Adapter Harness, PN 8859 | 4 - Vibration Mounts and Hardware |
| 1 - Coil Harness, PN 8863 | 4 - RPM Modules: 3K, 7K, 8K and 9K |

WARNING: Before installing the MSD Distributor, disconnect the battery cables. When disconnecting the battery cables, always remove the Negative (-) cable first and install it last.

FEATURES

RPM LIMITERS

The 7AL-2 Plus Ignition is equipped with a 2-step rev control. The Ignition will accept two rpm modules so two different rev limits can be set. One rev limit can be used for overrev protection while the second limit can be activated on the starting line for a lower rpm limit to assist in staging and for consistent holeshots. When 12 volts are applied to the 2-step terminal (2'S'), Module 1 is active. Module 2 is active when there is no 12 volts.

CYLINDER SELECT

This ignition can be used on 2, 4, 6 (even-fire) or 8-cylinder engines. The ignition is set for 8-cylinder operation. To program the unit for other engines, remove the one screw that holds the cover to reveal three wire loops (Figure 1). Cutting a wire loop determines the cylinder selection.

SPARK LED

When the coil fires, current is sensed and this LED will flash. This confirms that the ignition has received a trigger signal and that the coil and ignition are working properly. (If the coil is not connected, the LED will not flash.) When the engine is running, it will appear solid.

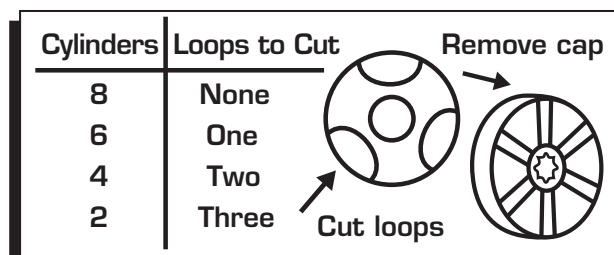

Figure 1 Cylinder Programming.

GENERAL INFORMATION

BATTERY

An MSD 7AL-2 Plus Ignition Control will operate on any negative ground, 12 volt electrical system with a distributor. The MSD can be used with 16 volt batteries and can withstand a momentary 24 volts in case of jump starts. The Ignitions will deliver full voltage with a supply of 10 - 18 volts and will operate with a supply voltage as low as five volts.

If your application does not use an alternator, allow at least 15 amp/hour for every half hour of operation. If the engine is cranked with the same battery or other accessories such as an electric fuel or water pump, the amp/hour rating should be higher.

COILS

The MSD 7AL-2 Plus Ignition can be used with many stock coils and aftermarket coils designed to replace the stock coils such as the Blaster line of coils. For short duration racing, like drag racing, the MSD Pro Power Coil, PN 8201, is recommended. For use on the street or long duration events, use coil PN 8251 or PN 8261. For more information on recommended coils, consult the supplied Coil Application Chart or check with the manufacturer of your coil. If you have any questions concerning coils, contact our Customer Service Department at (915) 855-7123.

TACHOMETERS

The MSD Ignition features a Tach Output Terminal on the terminal strip. This terminal provides a trigger signal for tachometers, a shift light or other add-on rpm activated devices. The Tach Output Terminal produces a 12 volt square wave signal with a 33% duty cycle.

Some vehicles with factory tachometers may require a Tach Adapter to operate with the MSD. For more information on Tachometers and MSD Tach Adapters, see the Tachometer Section on page 6.

If your GM vehicle has an inline filter it may cause the tach to drop to zero on acceleration. If this occurs, bypass the filter.

SPARK PLUGS AND WIRES

Spark plug wires are very important to the operation of your ignition system.

A good quality, helically wound wire and proper routing are required to get the best performance from your ignition, such as the MSD Heli-Core or 8.5mm Super Conductor.

Note: Solid Core spark plug wires cannot be used with an MSD Ignition.

A helically, or spiral wound wire must be used. This style wire provides a good path for the spark to follow while keeping Electro Magnetic Interference (EMI) to a minimum. Excessive EMI, such as the amount that solid core wires produce, will interfere with the operation of the MSD and other electronics on your car.

Spark Plug Wire Routing: Correct routing of the plug wires is also important to performance. Wires should be routed away from sharp edges and engine heat sources. If there are two wires that are next to each other in the engine's firing order, the wires should be routed away from each other to avoid inducing a spark into the other wire. For example, in a Chevy V8, the firing order is 1-8-4-3-6-5-7-2. The #5 and #7 cylinders are next to each other in the engine and in the firing order. If the voltage from the #5 wire is induced into #7 detonation could occur and cause engine damage.

To add more heat protection to your plug wires, MSD offers Pro-Heat Guard, PN 3411. This is a glass woven and silicone coated protective sleeve that you slide over your plug wires. For extra protection of the spark plug boots, MSD offers Pro-Heat Boot Guard, PN 3412.

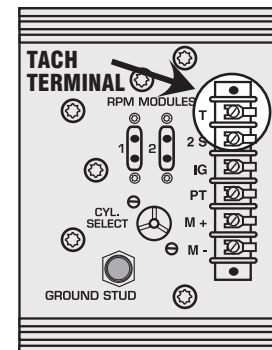

Figure 2 Tach Terminal.

Spark Plugs: Choosing the correct spark plug design and heat range is important when trying to get the best performance possible. Since there are so many engine combinations and manufacturers, MSD does not recommend which plug or gap is exactly right for your application.

It is recommended to follow the engine builder or manufacturer's specification for spark plugs. With that, you can then experiment with the plug gap to obtain the best performance. The gap of the plugs can be opened in 0.005" increments, then tested until the best performance is obtained. MSD judges the plug gap by compression and components:

Note: A larger plug gap taxes the cap, rotor and spark plug wires. Always inspect the cap and rotor to make sure they are in good condition.

| Compression | Spark Plug Gap |
|------------------|-----------------|
| Up to 10.5:1: | 0.050" - 0.060" |
| 10.5:1 - 13.0:1: | 0.040" - 0.050" |
| Above 13.0:1: | 0.035" - 0.040" |

These examples are just starting points to get you going in the right direction. Every application is different and should be tested and tuned.

MISCELLANEOUS INFORMATION

Sealing: Do not attempt to seal the MSD. All of the circuits of an MSD receive a thick conformal coating of Humi-Seal. This sealant protects the electronics from moisture. If you were to seal the unit, any moisture or water that may seep in through the wiring grommets will not be able to drain and may result in corrosion.

Welding: If you are welding on your vehicle, to avoid the chance of damage, always disconnect both Heavy Power cables of the MSD. (You should also disconnect the tach ground wire too).

Distributor Cap and Rotor: It is recommended to install a new distributor cap and rotor when installing the MSD Ignition Control. The cap should be clean inside and out especially the terminals and rotor tip. On vehicles with smaller caps, it is possible for the air inside the cap to become electrically charged causing crossfire which can result in misfire. This can be prevented by drilling a couple vent holes in the cap. The holes should be placed between the terminals, at rotor height and face away from the intake. If your environment demands it, place a small piece of non-metallic screen over the hole to act as a filter.

Initial Spark: It is normal, yet not very common, for the MSD to produce a spark when the ignition key is turned On. This is due to the capacitor being charged and if the pickup is in the right position, it could trigger the ignition momentarily. This could also occur when installing the positive battery cable.

MOUNTING

The MSD can be mounted in most positions. It can be mounted in the engine compartment as long as it is away from direct engine heat sources. It is not recommended to mount the unit in an enclosed area such as the glovebox.

When you find a suitable location to mount the unit, make sure the wires of the ignition reach their connections. Hold the Ignition in place and mark the location of the mounting holes. Use a 1/4" drill bit to drill the holes. Install the vibration mounts to the ignition and mount the unit.

WIRING

GENERAL WIRING INFORMATION

Wire Length: All of the wires of the MSD Ignition may be shortened as long as quality connectors are used or soldered in place. To lengthen the wires, use one size bigger gauge wire (10 gauge for the power leads and 16 gauge for the other wires) with the proper connections. All connections must be soldered and sealed.

Grounds: A poor ground connection can cause many frustrating problems. When a wire is specified to go to ground, it should be connected to the battery negative terminal, engine block or chassis. There should always be a ground strap between the engine and the chassis. Always securely connect the ground wire to a clean, paint free metal surface.

The 7AL-2 has a ground stud just to the left of the terminal strip. Use this to ground other MSD accessories (Figure 3).

Ballast Resistor: If your vehicle has a ballast resistor in line with the coil wiring, it is not necessary to bypass it. This is because this wire serves only as an On/Off switch. The MSD receives its main power directly from the battery.

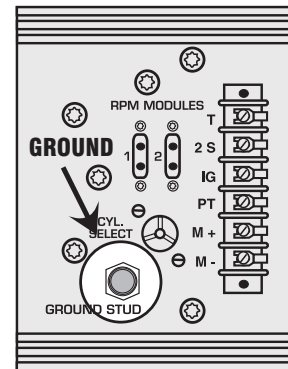

Figure 3 Ground Stud.

| Terminal | Wire | Function |
|----------------|-----------------|--|
| COIL + | ORANGE | Connects to the positive (+) terminal of the coil. This is the only wire that makes electrical contact with the coil positive terminal. |
| COIL - | BLACK | Connects to the negative (-) terminal of the coil. This is the only wire that makes electrical contact with the coil negative terminal. |
| BAT - | HEAVY BLACK | This wire connects to a good ground, either at the battery negative (-) terminal or to the engine. |
| BAT + | HEAVY RED | This wire connects directly to the battery positive (+) terminal or to a positive battery junction or the positive side of the starter solenoid. Note: Never connect to the alternator. |
| TACH | | This terminal delivers a 12 volt square wave signal as an output for a tachometer or devices that require an rpm signal. |
| 2-STEP | DARK BLUE | When this terminal is connected to 12 volts, RPM module 1 is active. When there is no 12 volts, RPM module 2 is active. |
| IGNITION | RED | Connects to a switched 12 volt source. Such as the ignition key or switch. |
| POINTS | WHITE | This wire is used to connect to the points, electronic ignition amplifier output or to the Yellow wire of an MSD Timing Accessory. When this wire is used, the Magnetic Pickup connector is not used. |
| MAG + MAG - | VIOLET GREEN | These wires are routed together in one harness from the Magnetic Pickup connector. The connector plugs directly into an MSD Distributor or Crank Trigger. It will also connect to factory magnetic pickups or other aftermarket pickups (Figure 4). The Violet wire is pos. (+) and the Green is neg. (-). When these wires are used, the Points Terminal is not. |

Noise Capacitor: MSD offers a Noise Capacitor or Filter to help eliminate EMI noise. This capacitor, PN 8830, will also protect the MSD and accessories from voltage and current spikes.

ROUTING WIRES

The MSD wires should be routed away from direct heat sources such as exhaust manifolds and headers and any sharp edges. The trigger wires should be routed separate from the other wires and spark plug wires. It is best if they are routed along a ground plane such as the block or firewall which creates an electrical shield. The magnetic pickup wires should always be routed separately and should be twisted together to help reduce extraneous interference (the harness supplied is already twisted).

| Common Mag Pickup Wires | | |
|----------------------------------|---------|---------|
| Distributor | Colors | |
| | Mag+ | Mag- |
| MSD | Org/Blk | Vio/Blk |
| MSD Crank Trigger | Org/Blk | Vio/Blk |
| Ford | Orange | Purple |
| Accel ^{46/48000} Series | Org/Blk | Vio/Blk |
| Accel ^{51/61000} Series | Red | Black |
| Chrysler | Org/Wht | Black |
| Mallory | Org/Blk | Vio/Blk |

Figure 4 Common Mag Pickup Wires.

The chart shows the polarity of other common magnetic pickups. If using a different magnetic pickup, use the MSD 2-Pin connector, available as PN 8824, for a direct plug-in installation.

WARNING: The MSD 7 Series Ignitions are capacitive discharge ignitions. High voltage is present at the coil primary terminals. Do not touch the coil or connect test equipment to the terminals.

PRESTART CHECK LIST

- The only wires connected to the coil terminals are the MSD Orange to coil positive and Black to coil negative.
- The small Red wire of the MSD is connected to a switched 12 volt source.
- The MSD power leads are connected directly to the battery positive and negative terminals.
- The battery is connected and fully charged if not using an alternator.
- The engine is equipped with at least one ground strap to the chassis.

TROUBLESHOOTING

Every MSD Ignition undergoes numerous quality control checks including a four hour burn-in test. If you experience a problem with your MSD, our research has shown that the majority of problems are due to improper installation or poor connections.

The Troubleshooting section has several checks and tests you can perform to ensure proper installation and operation of the MSD. If you have any questions concerning your MSD, call our Customer Support Department at (915) 855-7123, 7 - 6 mountain time.

TACH/FUEL ADAPTERS

If your tachometer does not operate correctly or if you experience a no-run situation with your foreign vehicle you probably need an MSD Tach Adapter. The chart below lists common tachometers and if an Adapter is necessary.

| Tachometer Compatibility List | | |
|-------------------------------|-----------------------|----------------------------|
| AFTERMARKET TACHOMETER | WHITE WIRE TRIGGER | MAGNETIC TRIGGER CONNECTOR |
| AUTOGAGE | 8910 | 8920 |
| AUTOMETER | NONE | NONE |
| FORD MOTORSPORTS | NONE | NONE |
| MALLORY | NONE | NONE |
| MOROSO | NONE | NONE |
| STEWART | 8910 | 8920 |
| S.W. & BI TORX | NONE | NONE |
| SUN | 8910 | 8920 |
| VDO | 8910 | 8920 |
| AMC (JEEP) | 8910 | 8920 |
| CHRYSLER | 8910 | 8920 |
| FORD (Before 1976) | 8910 | 8920 |
| FORD (After 1976) | 8910 | 8920 |
| GENERAL MOTORS | Bypass In-Line Filter | Bypass In-line filter |
| IMPORTS | 8910 | 8920 |

Note: On the list above, the trigger wire on tachometers that are marked NONE may be connected to the Tach Output Terminal on the MSD 7 Series Ignition Unit using the supplied Female Faston Receptacle.

INOPERATIVE TACHOMETERS

If your tachometer fails to operate with the MSD installed you may need an MSD Tach Adapter. Before getting an Adapter, try connecting your tachometer trigger wire to the tach output terminal on the side of the MSD. This output produces a 12 volt, square wave (see page 2). If the tach still does not operate, you will need a Tach Adapter. There are two Tach Adapters:

PN 8920: If you are using the Magnetic Pickup connector (Green and Violet wires) to trigger the MSD, you will need the PN 8920.

PN 8910: If your tachometer was triggered from the coil negative terminal (voltage trigger) and you are using the White wire to trigger the MSD you will need the PN 8910.

ENGINE RUN-ON

If your engine continues to run even when the ignition is turned Off you are experiencing engine Run-On. This usually only occurs on older vehicles with an external voltage regulator. Because the MSD receives power directly from the battery, it does not require much current to keep the unit energized. If you are experiencing run-on, it is due to a small amount of voltage going through the charging lamp indicator and feeding the small Red wire even if the key is turned off.

Early Ford and GM: To solve the Run-On problem, a Diode is supplied with the MSD in the parts bag. By installing this Diode in-line of the wire that goes to the Charging indicator, the voltage is kept from entering the MSD. Figure 5 shows the proper installation for early Ford and GM vehicles.

Note: Diodes are used to allow voltage to flow only one way. Make sure the Diode is installed facing the proper direction (as shown in Figure 5).

Ford: Install the Diode inline to the wire going to the "1" terminal.

GM: Install the Diode in-line to the wire going to terminal “4”.

GM 1973 - 1983 with Delcotron Alternators

GM Delcotron Alternators use an internal voltage regulator. Install the Diode in-line on the smallest wire exiting the alternator (Figure 6). It is usually a Brown wire.

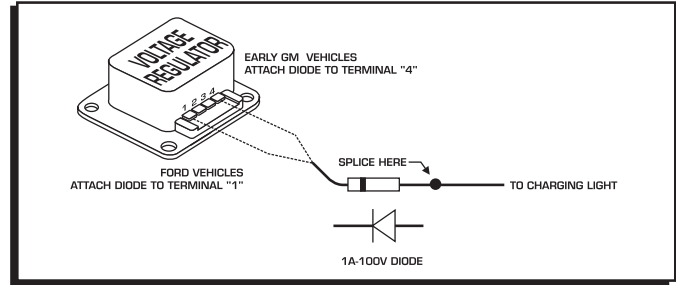

Figure 5 Installing the Diode to a GM or Ford Vehicle.

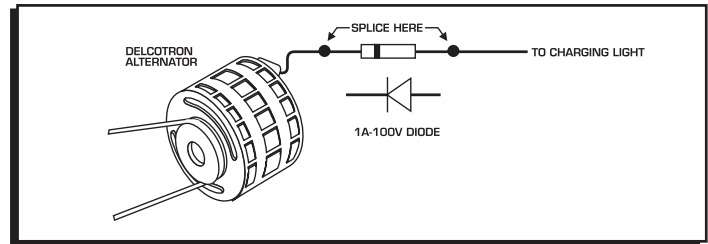

Figure 6 Installing the Diode to a 1973-1983 GM Vehicle.

MISSES AND INTERMITTENT PROBLEMS

Experience at the races has shown that if your engine is experiencing a miss or hesitation at higher rpm, it is usually not directly ignition related. Most probable causes include a coil or plug wire failure, arcing from the cap or boot plug to ground or spark ionization inside the cap. Several items to inspect are:

- Always inspect the plug wires at the cap and at the plug for a tight connection and visually inspect for cuts, abrasions or burns.
- Inspect the Primary Coil Wire connections. Because the MSD is a Capacitive Discharge ignition and it receives a direct 12 volt source from the battery, there will not be any voltage at the Coil Positive (+) terminal even with the key turned On. During cranking or while the engine is running, very high voltage will be present and no test equipment should be connected.
- Make sure that the battery is fully charged and the connections are clean and tight. If you are not running an alternator this is an imperative check. If the battery voltage falls below 10 volts during a race, the MSD output voltage will drop.

WARNING: Do not touch the coil terminals during cranking or while the engine is running.

- Is the engine running lean or excessively rich? Inspect the spark plugs and fuel system.
- Inspect all wiring connections for corrosion or damage. Remember to always use proper connections followed by soldering and seal the connections completely.

LED: The LED on the ignition will assist in troubleshooting. If the LED does not flash, there is no current through the primary coil wires. This could be due to poor connections at the coil, the coil itself or the ignition. Once you confirm that the trigger signal is working, try a different coil. See page 8 to test for spark.

If everything checks positive, use the following procedure to test for spark. MSD also offers an Ignition Tester, PN 8998. This tool allows you to check your complete ignition system while it is in the car as well as the operation of rpm limits, activated switches and shift lights.

CHECKING FOR SPARK

If triggering the ignition with the White wire:

1. Make sure the ignition switch is in the "Off" position.
2. Remove the coil wire from the distributor cap and set the terminal approximately 1/2" from ground.
3. Disconnect the MSD White wire from the distributor's points or ignition amplifier.
4. Turn the ignition to the "On" position. Do not crank the engine.
5. Rapidly tap the White wire to ground **several times**. When the wire is pulled from ground, a spark should jump from the coil wire to ground. If spark is present, the ignition is working properly. If there is no spark skip to step 6 below:

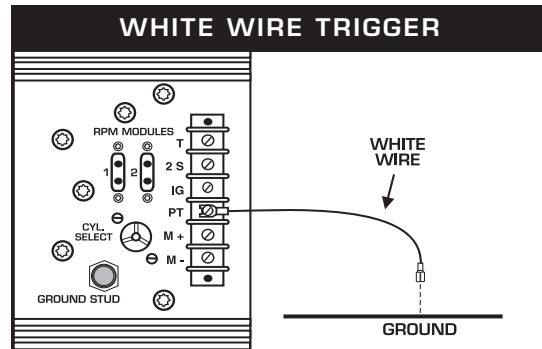

Figure 7 Checking for Spark with a White Wire.

If triggering with the Magnetic Pickup:

1. Make sure the ignition switch is in the "Off" position.
2. Remove the coil wire from the distributor cap and set the terminal approximately 1/2" from ground.
3. Disconnect the MSD magnetic pickup wires from the distributor.
4. Turn the ignition to the "On" position. Do not crank the engine.
5. With a small jumper wire, short the MSD's Green and Violet magnetic pickup wires together. Each time you break this ground (rapidly), a spark should jump from the coil wire to ground. If spark is present, the ignition is working properly. If there is no spark skip to step 6 below:

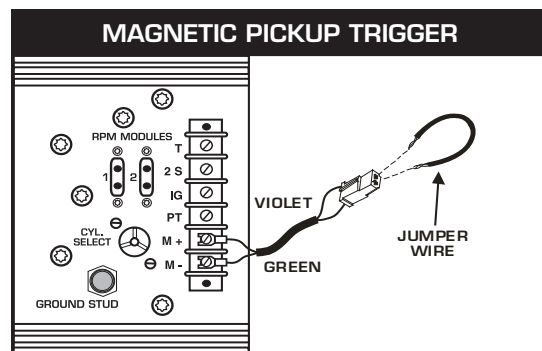

Figure 8 Checking for Spark with Magnetic Pickup.

6. If there is no spark:

- A. Inspect all of the wiring.
- B. Substitute another coil and repeat the test. If there is now spark, the coil is at fault.
- C. If there is still no spark, check to make sure there is 12 volts on the small Red wire from the MSD when the key is in the "On" position. If 12 volts is not present, find another switched 12 volt source and repeat the test.
- D. If, after following the test procedures and inspecting all of the wiring, there is still no spark, the MSD Ignition is in need of repair. See the Warranty and Service section for information.

If there is no spark, but the LED flashes, check for a coil problem.

The following wiring diagrams illustrate numerous installations on different vehicles and applications. If you experience difficulties when installing your MSD, contact our Customer Support Department at (915) 855-7123 (7 - 6 Mountain time) or e-mail us at: msdtech@msdignition.com

MSD SYSTEMS Installing to Points/Amplifier Style Ignition.

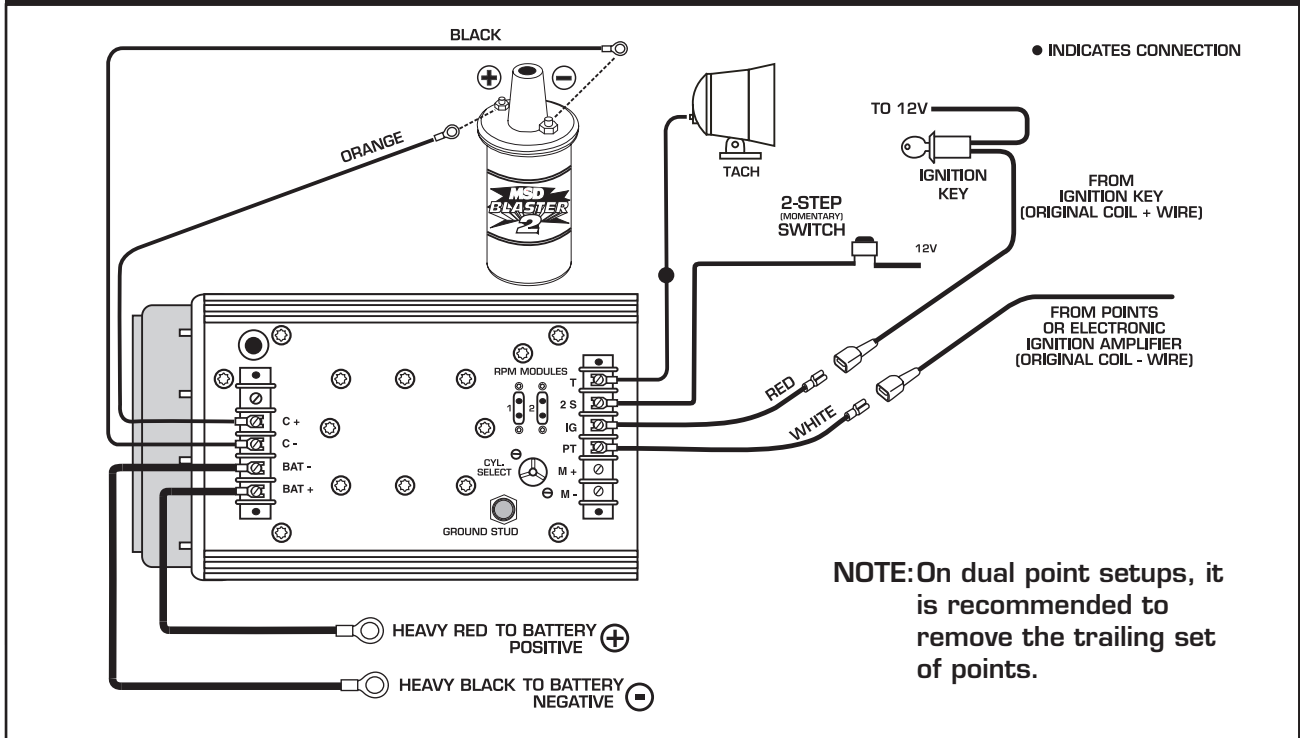

MSD SYSTEMS Installing to an MSD Distributor/Crank Trigger.

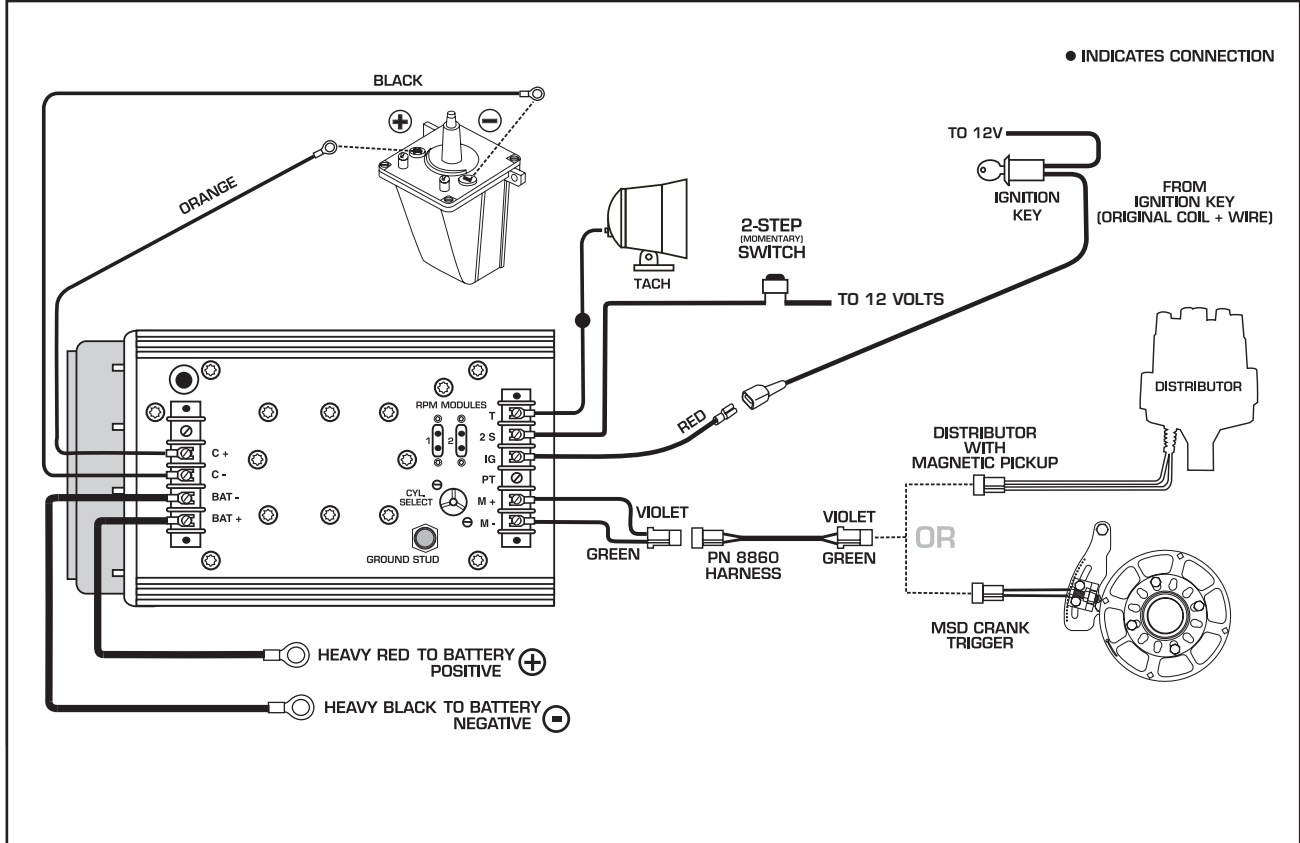

MSD SYSTEMS Installing to an MSD Ready-to-Run Distributor

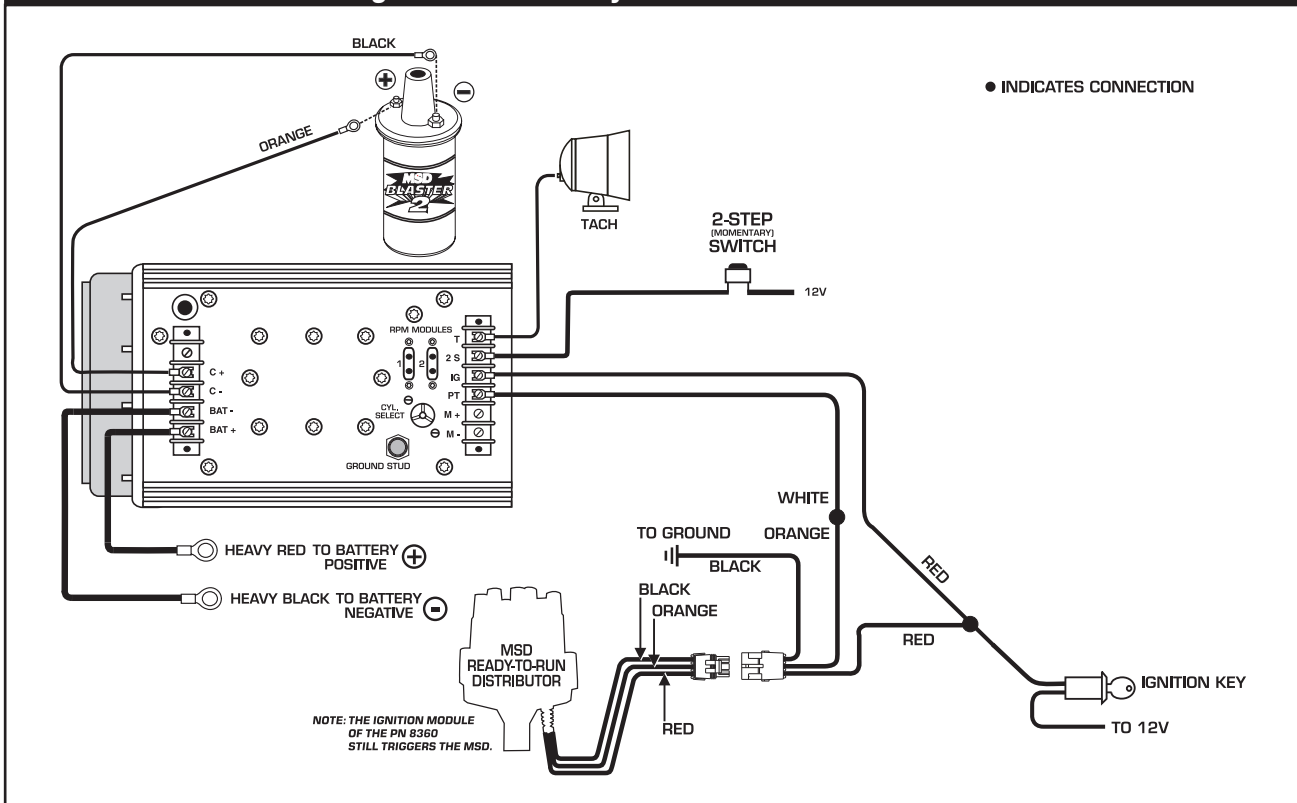

MSD SYSTEMS With an MSD Timing Control.

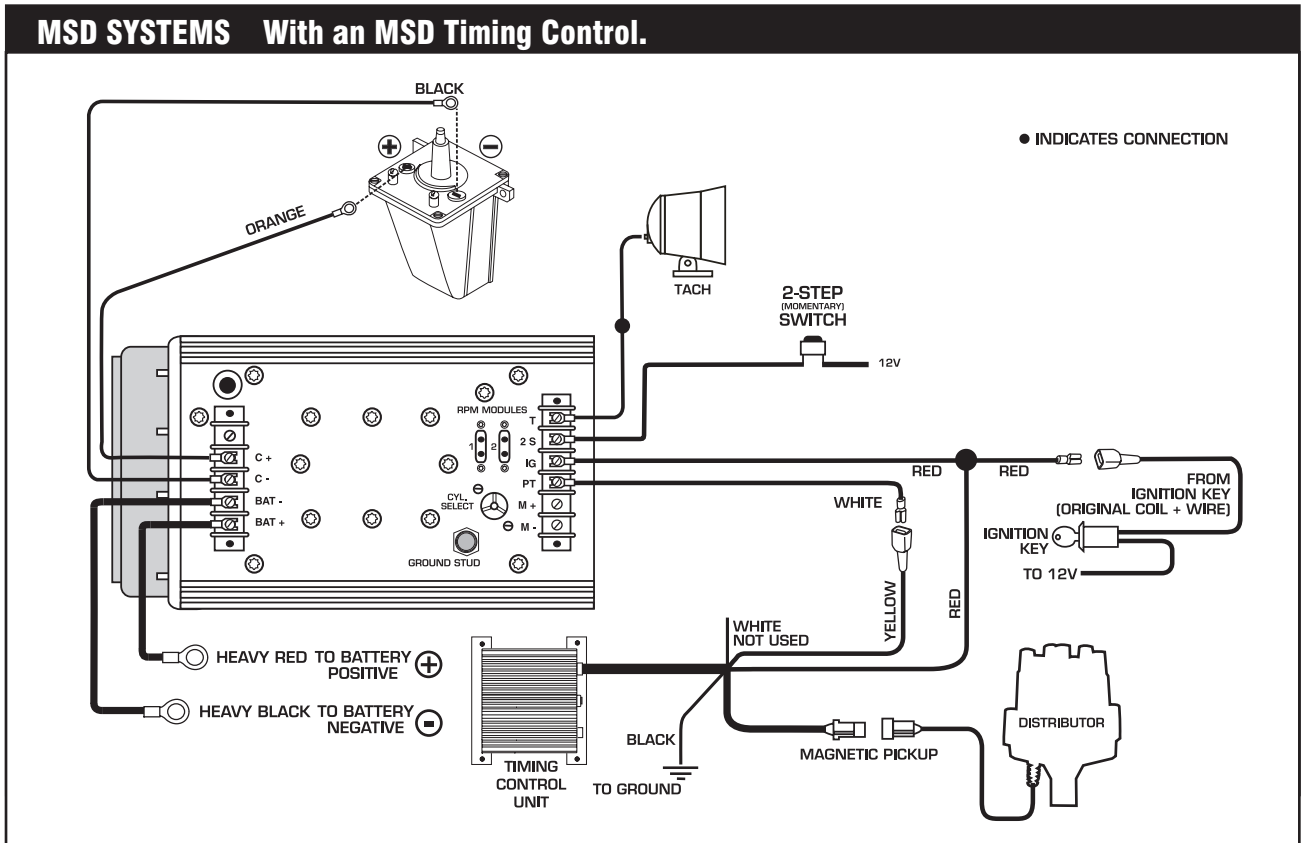

GM IGNITIONS Wiring with an MSD to GM Wiring Harness.

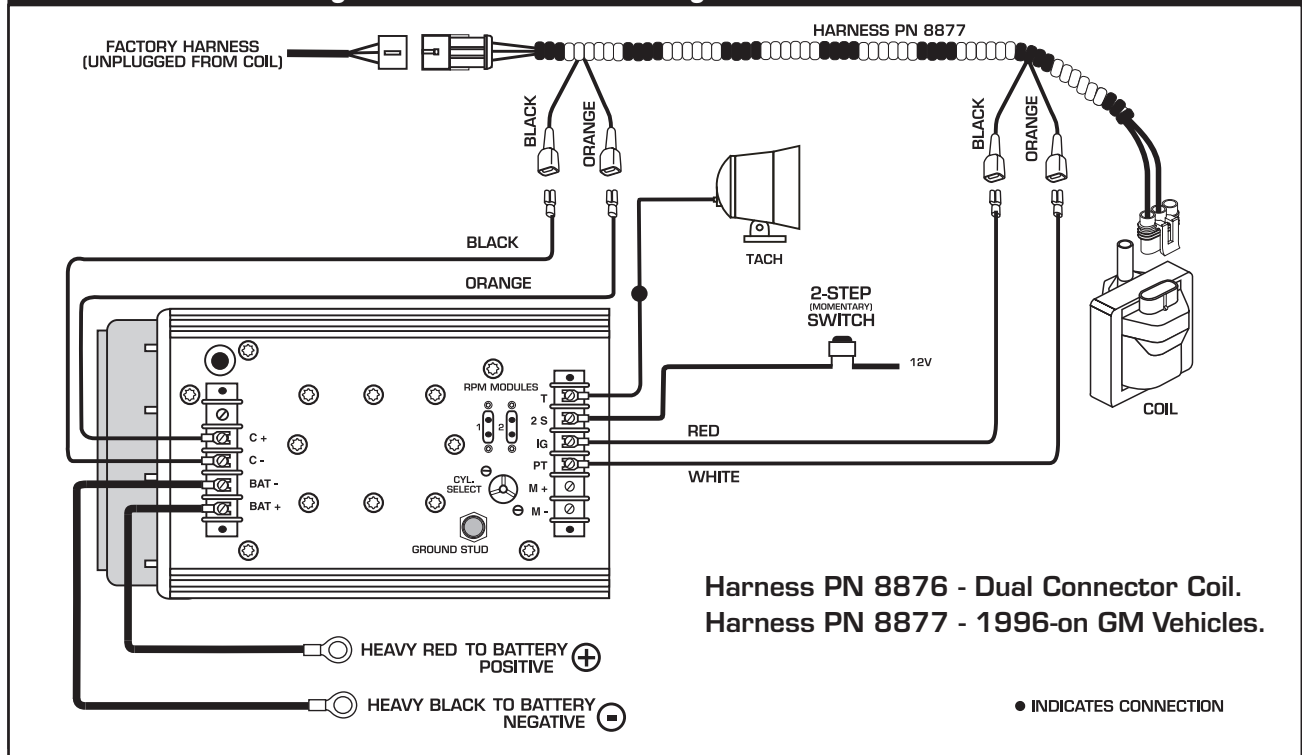

FORD IGNITIONS Wiring a Ford TFI with Harness, PN 8874.

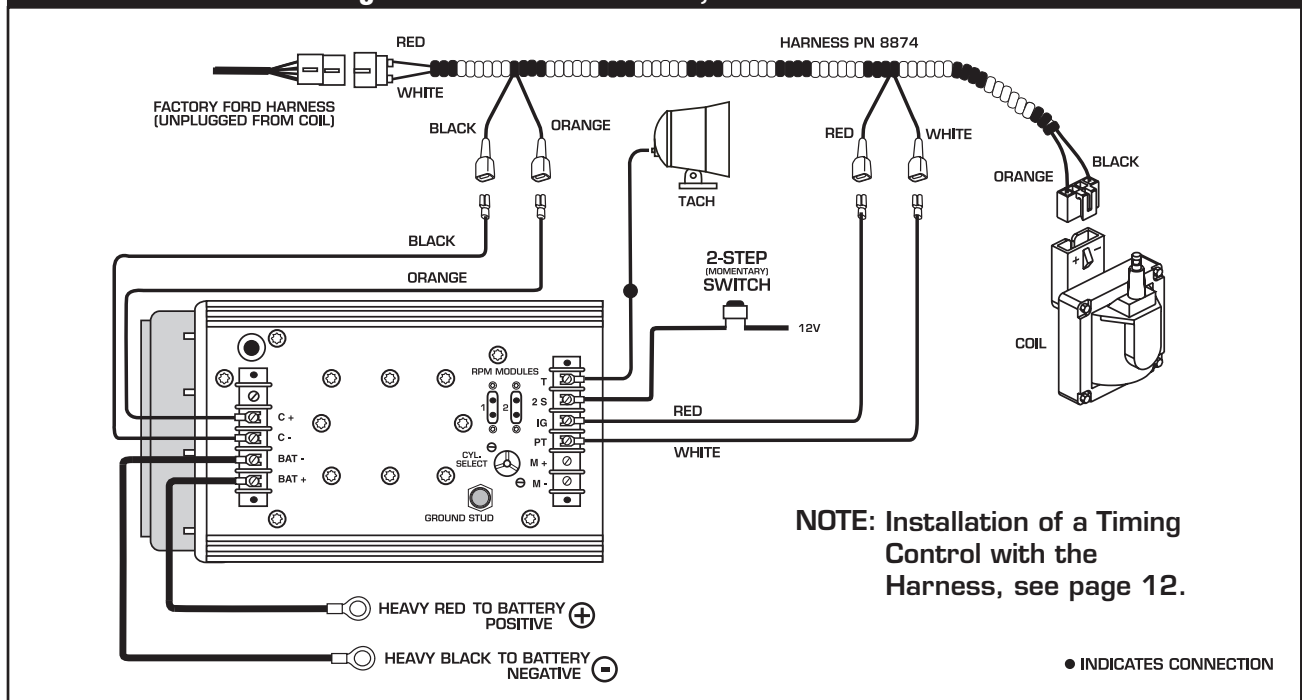

GM IGNITIONS Wiring with an MSD to GM Wiring Harness and a Timing Control.

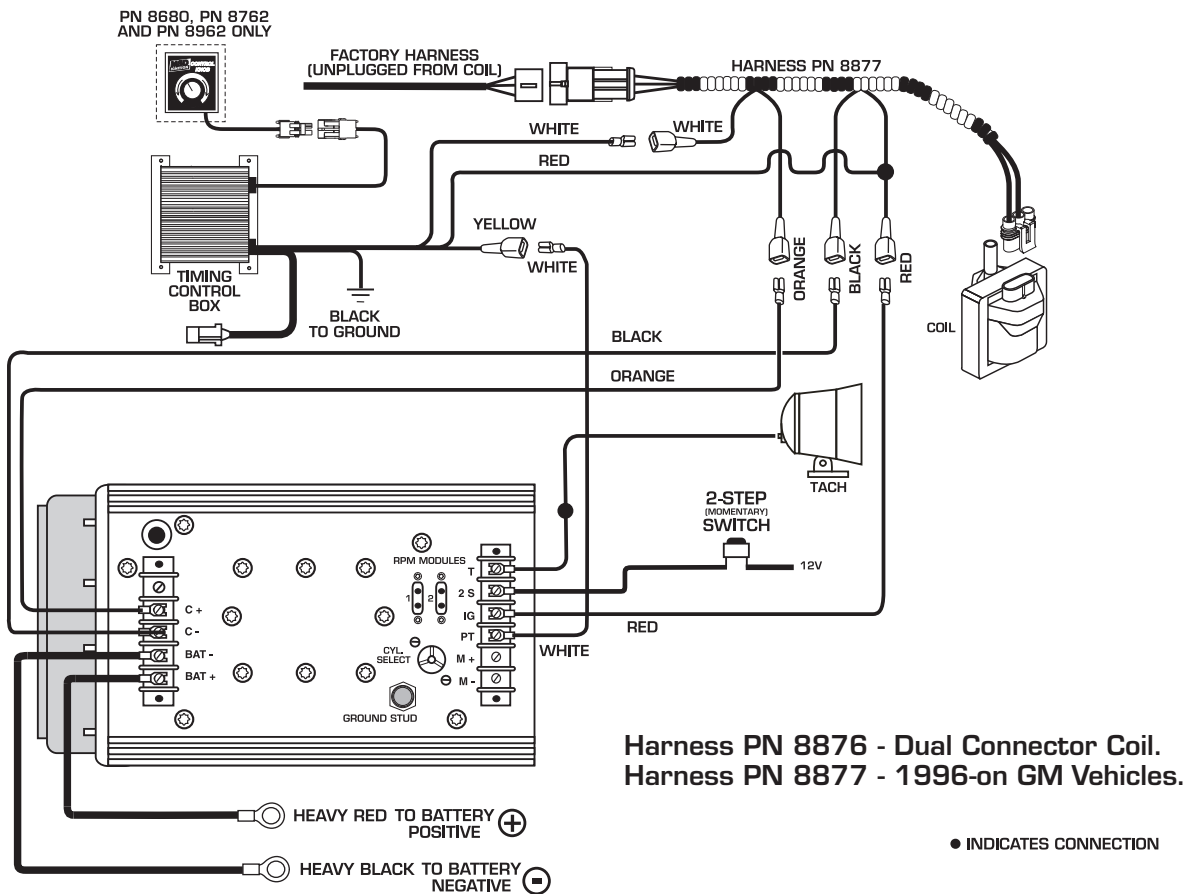

GM IGNITIONS GM Large Cap HEI Distributors.

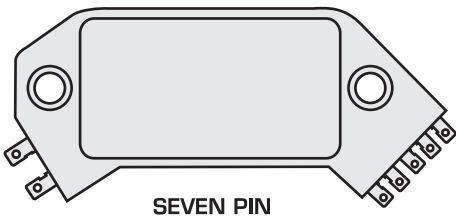
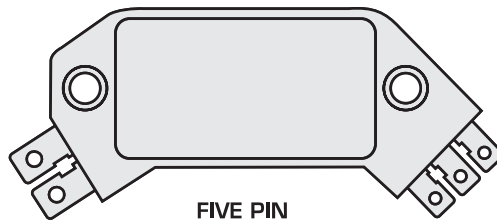
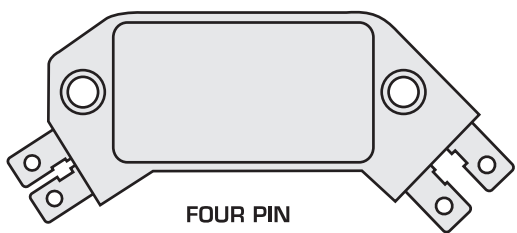

There are three different large cap HEI distributors. To identify which of the following diagrams fit your specific application, remove the distributor cap and rotor and locate the ignition module at the base of the distributor. Count the number of terminals on both ends of the module and follow the corresponding diagram. GM used 4, 5 and 7-pin modules in these distributors.

NOTE: Some 5-pin models may experience a hesitation or stall on deceleration. If this occurs, contact MSD Tech Line for the required bolt-in diode to correct the problem. MSD Tech Line (915) 855-7123.

NOTE: The stock rotor button must be replaced with an MSD Low Restraint Bushing PN 8412.

GM IGNITIONS Wiring an HEI 4-pin Module (Magnetic Pickup Trigger).

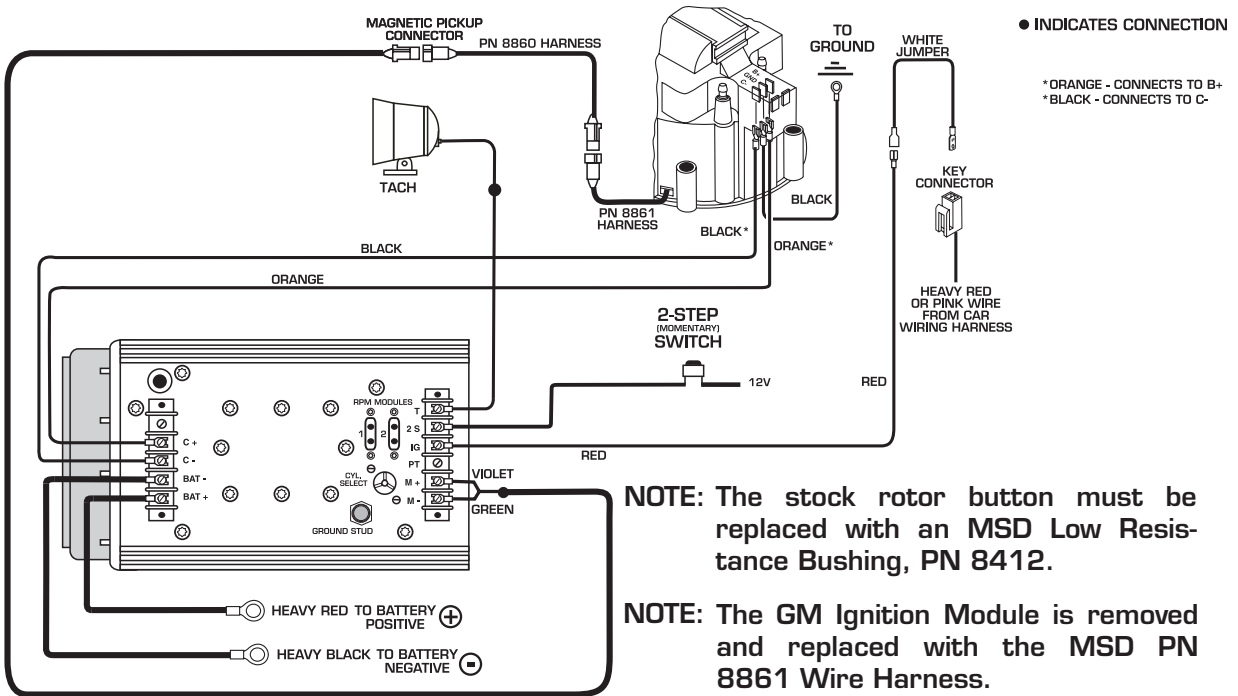

NOTE: The stock rotor button must be replaced with an MSD Low Resistance Bushing, PN 8412.

NOTE: The GM Ignition Module is removed and replaced with the MSD PN 8861 Wire Harness.

GM IGNITIONS Wiring an HEI 5 or 7-pin Module (Amplifier Trigger).

NOTE: Some 5-pin models may experience a hesitation or stall on deceleration. If this occurs, contact MSD Tech Line for the required bolt-in diode to correct the problem. MSD Tech Line (915) 855-7123.

NOTE: The stock rotor button must be replaced with an MSD Low Resistance Bushing, PN 8412.

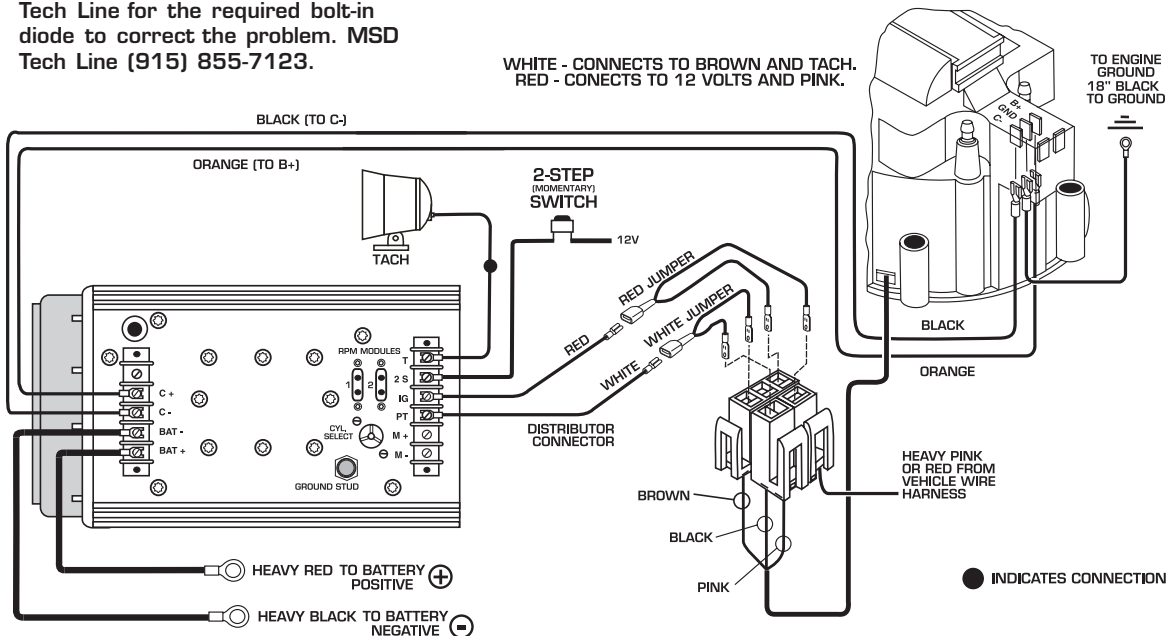

FORD IGNITIONS Wiring a Ford DuraSpark using Magnetic Pickup Trigger.

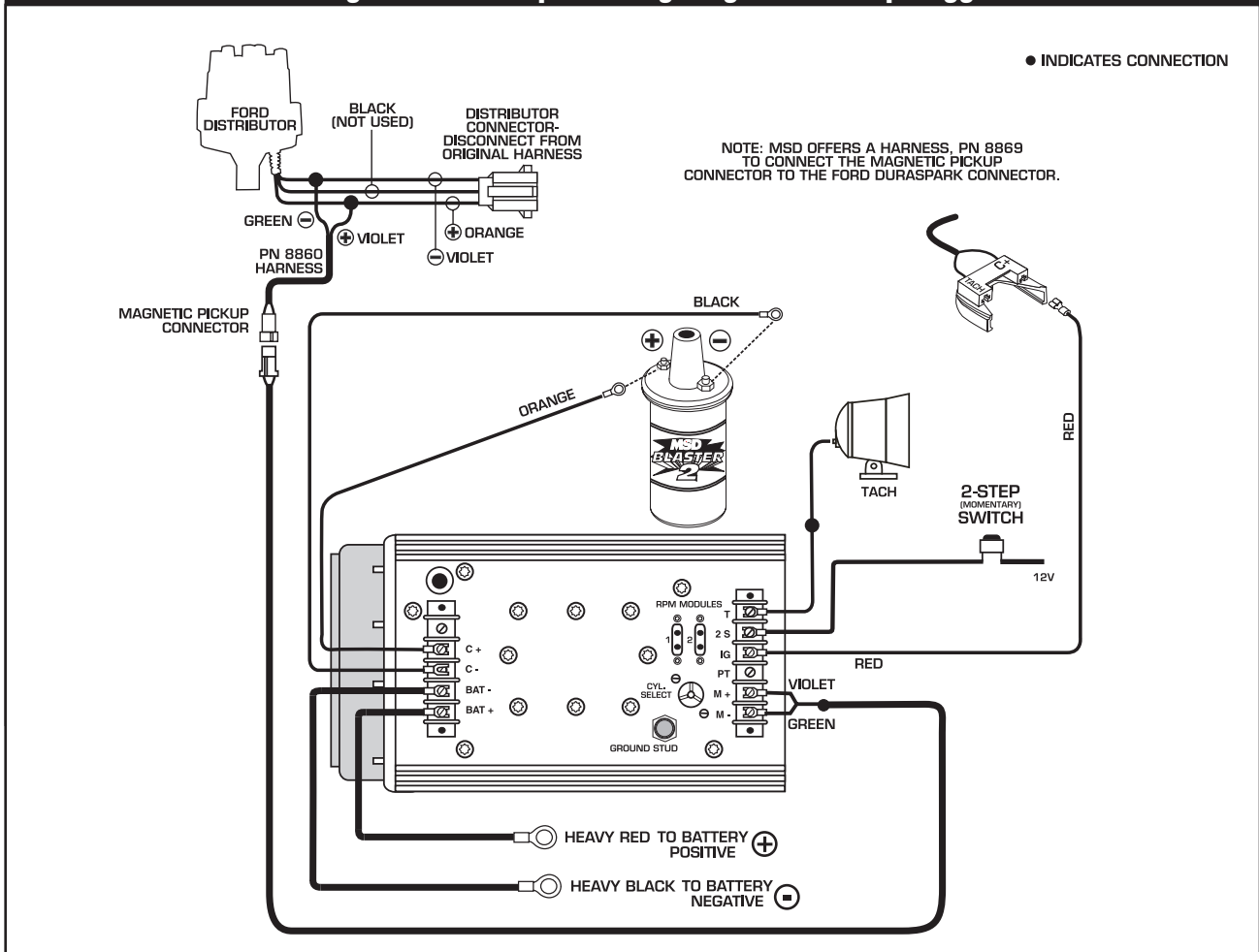

HONDA IGNITIONS Wiring a Honda with Internal Coil.

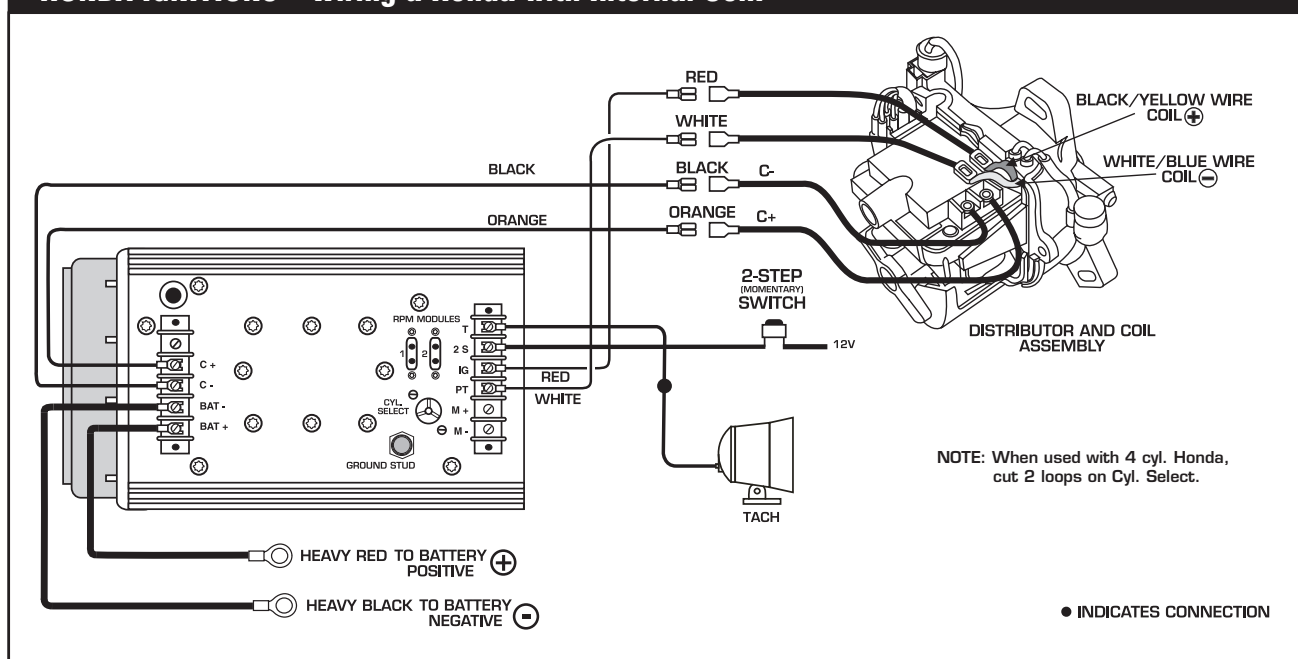

CHRYSLER IGNITIONS Wiring a Chrysler Electronic Ignition using Magnetic Pickup Trigger.

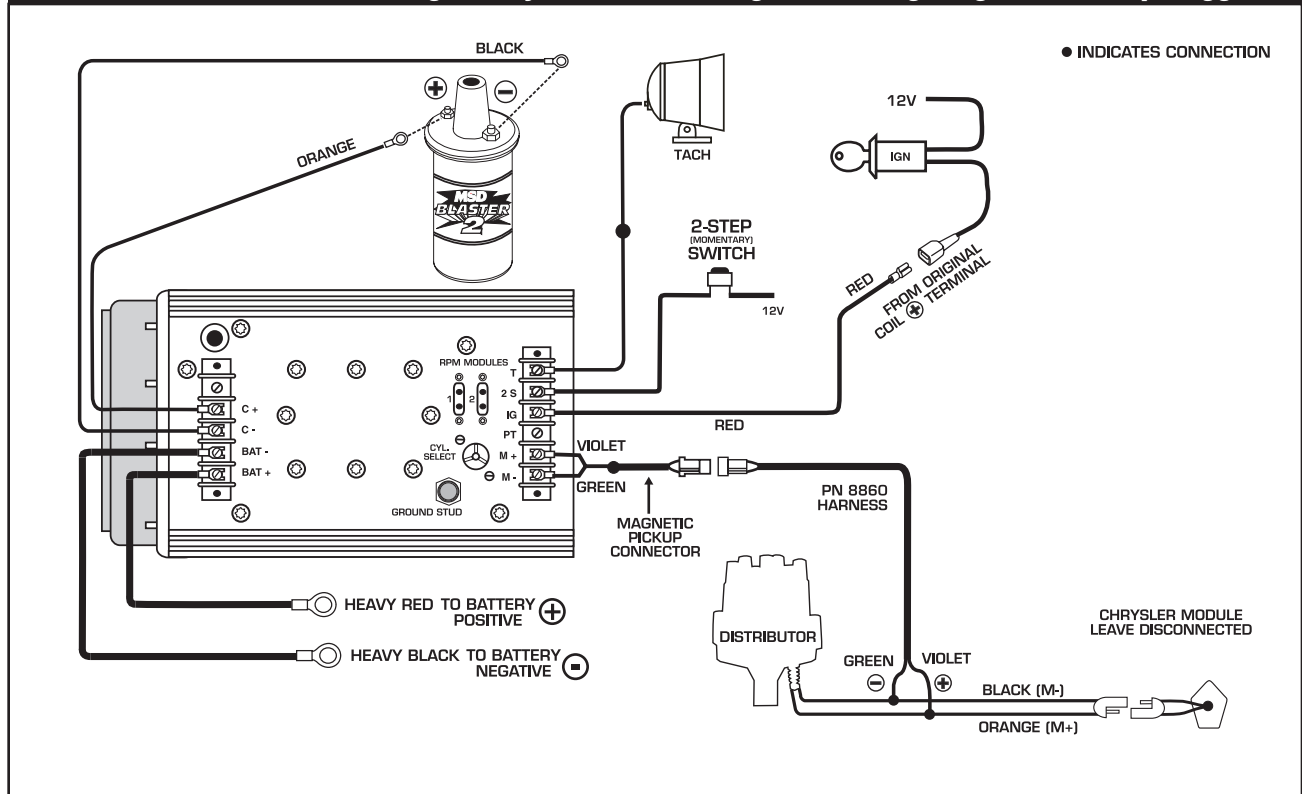

AFTERMARKET COMPONENTS Wiring a Mallory Unilite or 9000 Series using Points Trigger.

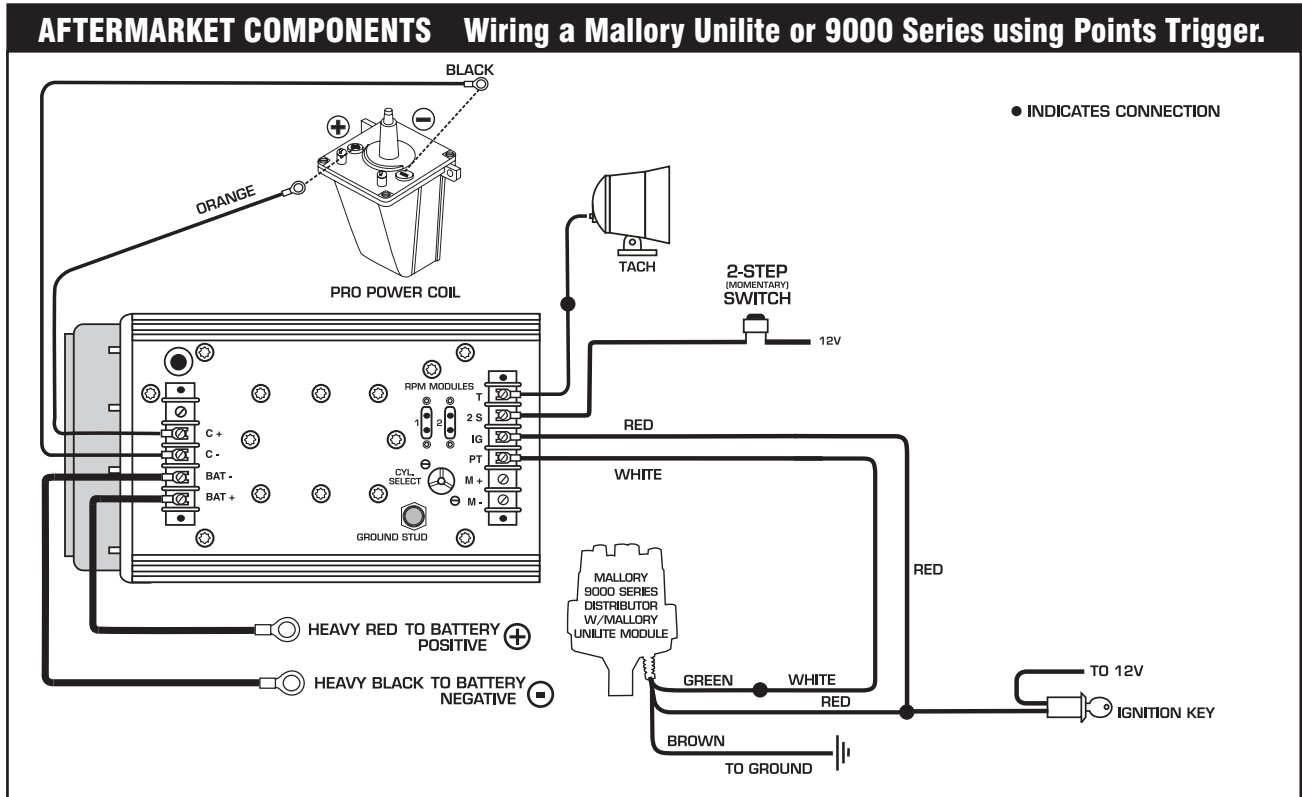

AFTERMARKET COMPONENTS Wiring an Accel BEI Distributor using Magnetic Pickup.

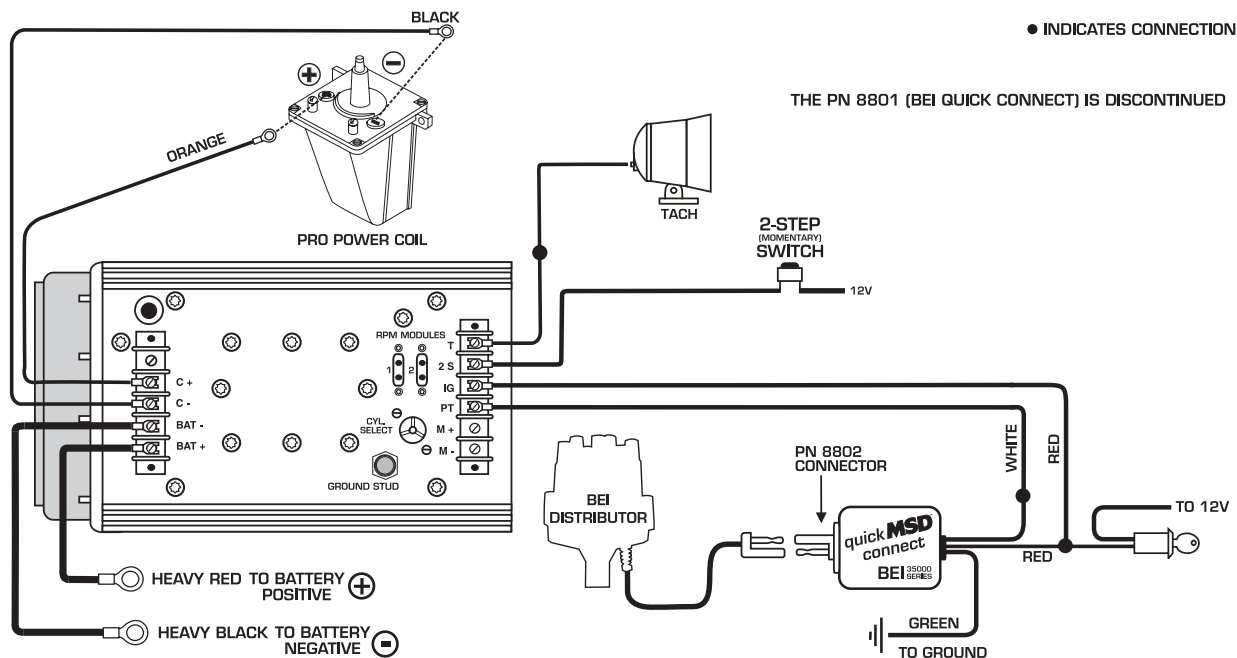

Service

In case of malfunction, this MSD component will be repaired free of charge according to the terms of the warranty. When returning MSD components for warranty service, **Proof of Purchase** must be supplied for verification. After the warranty period has expired, repair service is based on a minimum and maximum fee.

All returns must have a Return Material Authorization (RMA) number issued to them before being returned. To obtain an RMA number please contact MSD Customer Service at 1 (888) MSD-7859 or visit our website at www.msdpower.com/rma to automatically obtain a number and shipping information.

When returning the unit for repair, leave all wires at the length in which you have them installed. Be sure to include a detailed account of any problems experienced, and what components and accessories are installed on the vehicle. The repaired unit will be returned as soon as possible using Ground shipping methods (ground shipping is covered by warranty). For more information, call MSD at (915) 855-7123. MSD technicians are available from 7:00 a.m. to 5:00 p.m. Monday - Friday (mountain time).

Limited Warranty

MSD warrants this product to be free from defects in material and workmanship under its intended normal use*, when properly installed and purchased from an authorized MSD dealer, for a period of one year from the date of the original purchase. This warranty is void for any products purchased through auction websites. If found to be defective as mentioned above, it will be repaired or replaced at the option of MSD. Any item that is covered under this warranty will be returned free of charge using Ground shipping methods.

This shall constitute the sole remedy of the purchaser and the sole liability of MSD. To the extent permitted by law, the foregoing is exclusive and in lieu of all other warranties or representation whether expressed or implied, including any implied warranty of merchantability or fitness. In no event shall MSD or its suppliers be liable for special or consequential damages.

*Intended normal use means that this item is being used as was originally intended and for the original application as sold by MSD. Any modifications to this item or if it is used on an application other than what MSD markets the product, the warranty will be void. It is the sole responsibility of the customer to determine that this item will work for the application they are intending. MSD will accept no liability for custom applications.